

**MAKE X**

**V2.0**

2022-2023 Makex Robotics Competition

# **RULES GUIDE**

**MAKEX EXPLORER**

Edited By Makex Robotics Competition Committee

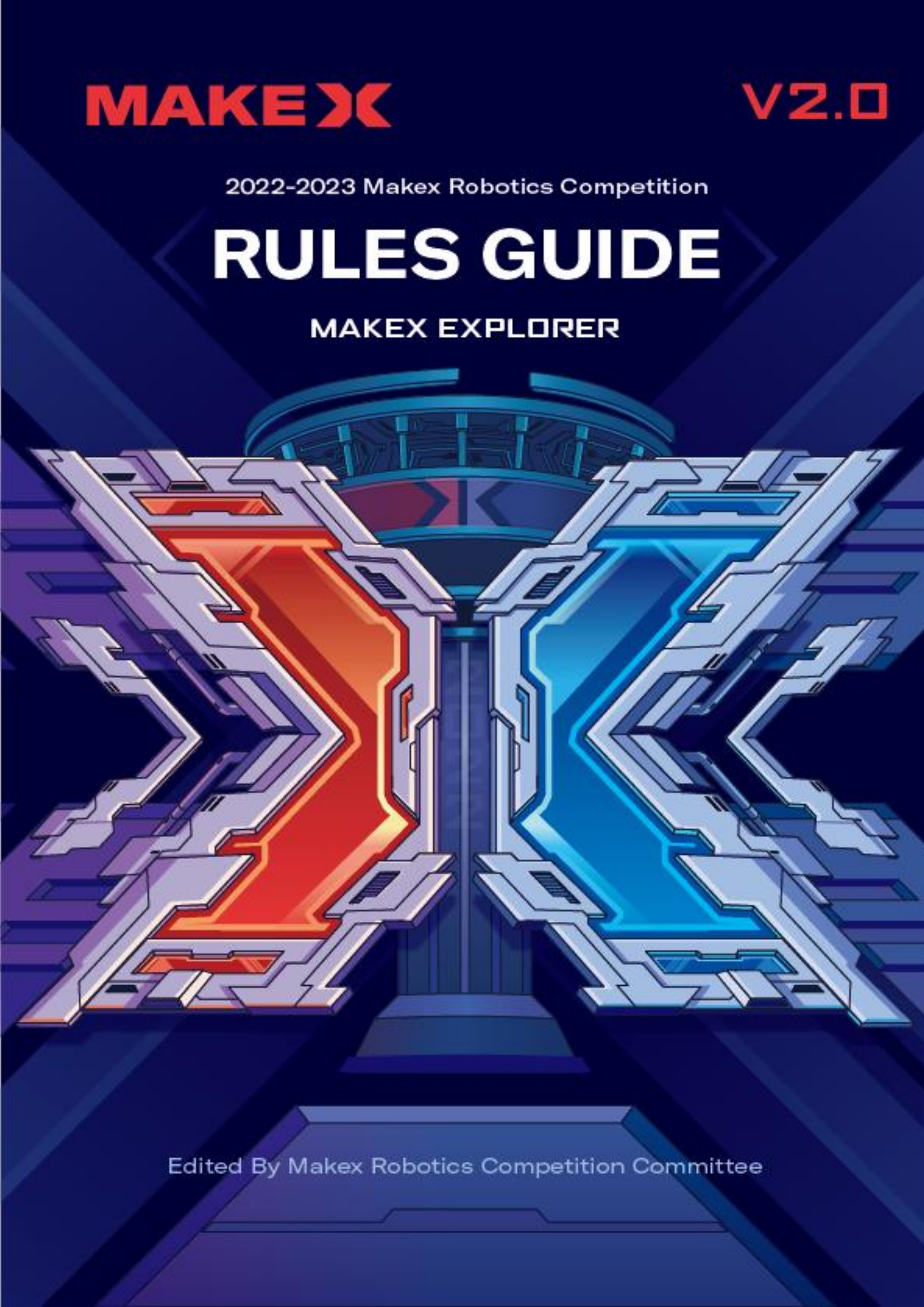



**Updates:**

| Date    | Version | Modifications Record  |
|---------|---------|---|
| 2021.09 | 1.0     | 2022 Season MakeX Explorer Rules Guide First Published.   |
| 2023.01 | 2.0     | <p>2022-2023 Season MakeX Explorer Rules Guide First Published.</p> <ul style="list-style-type: none"> <li>● Updated the age requirement of contestants</li> <li>● Deleted the “modification stage” in the competition procedure</li> <li>● Optimized the ranking rules of elimination round</li> <li>● Added the instruction of net in the goal area</li> <li>● Added the “Flag placement area” and relative statement</li> <li>● Elaborated the description of the environment flag</li> <li>● Added the “Inserting Environmental Flag” mission into the automatic stage</li> <li>● Elaborated the judgment statement of mission “Inserting Environmental Flag”</li> <li>● Updated the statement of penalty in the operation rules</li> <li>● Deleted the modification rules</li> </ul> |



## CONTENTS

|  |           |
|--|-----------|
| <b>1. Introduction .....</b>                                       | <b>5</b>  |
| 1.1 <i>About MakeX</i> .....                                       | 5         |
| 1.2 <i>MakeX Spirit</i> .....                                      | 5         |
| 1.3 <i>About MakeX Explorer</i> .....                              | 6         |
| <b>2. Competition Application .....</b>                            | <b>7</b>  |
| 2.1 <i>Participation Requirements</i> .....                        | 7         |
| 2.2 <i>Registration and Application</i> .....                      | 7         |
| <b>3. Competition Procedure .....</b>                              | <b>8</b>  |
| <b>4. Competition Details .....</b>                                | <b>13</b> |
| 4.1 <i>Introduction</i> .....                                      | 13        |
| 4.2 <i>Arena</i> .....   | 14        |
| 4.3 <i>Lists of Props</i> .....                                    | 20        |
| 4.4 <i>Missions Introduction and Scoring State Judgement</i> ..... | 22        |
| 4.5 <i>Scoring Explanation</i> .....                               | 25        |
| 4.6 <i>Single Match Flow</i> .....                                 | 26        |
| <b>5. Technical Specifications .....</b>                           | <b>28</b> |
| 5.1 <i>Specifications for Robot Construction</i> .....             | 28        |
| 5.2 <i>Specifications for Environmental Flag</i> .....             | 34        |
| <b>6. Competition Rules .....</b>                                  | <b>35</b> |
| 6.1 <i>Penalty explanation</i> .....                               | 35        |
| 6.2 <i>Operation Rules</i> .....                                   | 37        |
| <b>7. Appeal and Arbitration .....</b>                             | <b>45</b> |
| 7.1 <i>Results Confirmation</i> .....                              | 45        |
| 7.2 <i>Appeal Procedure and Valid Appeal Period</i> .....          | 45        |



7.3 *Invalid Appeal* ..... 46

7.4 *Arbitration Procedure* ..... 47

**8. Statement** ..... **48**

8.1 *Rules Explanation* ..... 48

8.2 *Disclaimer* ..... 48

8.3 *Copyright Declaration* ..... 49

**Appendix 1. Awards and Annual Points** ..... **50**

**Appendix 2. Engineering Notebook Guideline** ..... **52**

**Appendix 3. Robot Self-Check Form** ..... **54**

**MakeX Explorer Robot Self-Check Form** ..... **54**

**Appendix 4. MakeX Explorer Eco-Pioneer Penalties List** ..... **57**

**Appendix 5. MakeX Explorer Eco-Pioneer Score Sheet** ..... **62**

**Appendix 6. Supplementary Explanation of Competition Procedure** ..... **63**

**Appendix 7. Competition Resources** ..... **64**



# 1. Introduction

## 1.1 About MakeX

MakeX is an international robotics competition and education platform that promotes multidisciplinary learning within the fields of science and technology. It aims at building a world where STEAM education is highly appreciated and where young people are passionate about innovation by engaging them in exciting Robotics Competition, STEAM Carnival, Tech Event, Educational Conference etc.

As the core activity of MakeX, the namesake MakeX Robotics Competition provides exciting, challenging and high-level competitions in the spirit of creativity, teamwork, fun and sharing. It is committed to inspiring young people to learn Science (S), Technology (T), Engineering (E), Art (A) and Mathematics (M) and apply such knowledge in solving real-world problems.

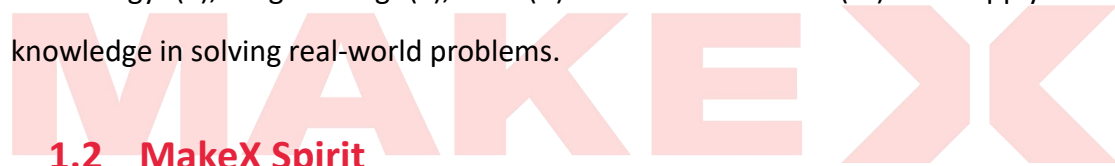

## 1.2 MakeX Spirit

**Creativity:** we advocate curiousness and innovation, encouraging all contestants to create unique high-tech works with their talent, and challenge themselves for continuous progress!

**Teamwork:** we advocate solidarity and friendship, encouraging all contestants to develop a sense of responsibility and enterprising spirit, and sincerely working with their partners for win-win development!

**Fun:** we encourage contestants to build a positive, healthy mindset in the competition. Enjoy the journey and grow in the process.

**Sharing:** we encourage contestants to have an open mind as a maker and share their knowledge, responsibility, and joy with everyone, including their teammates and competitors.



MakeX spirit is the cultural cornerstone of the MakeX Robotics Competition. We hope to provide a platform for all contestants, mentors and industry experts to exchange ideas, study and grow up, and help young people acquire new skills during creation, learn to respect others in teamwork, gain an enjoyable life experience in the competition, take delight in sharing with the society their knowledge and responsibility, and work hard to achieve their grand aspiration of changing the world and creating the future !

### **1.3 About MakeX Explorer**

MakeX Explorer is a confrontational competition program for elementary and junior high school students aged 8-15. This program fully integrates the essence of sports events and is highly interesting and a delight to watch. The competition requires the contestants to design and build robots from scratch, which systematically develops the contestants' comprehensive abilities in robot design, mechanical construction, and programming. Also, the form of alliance confrontation improves the contestants' ability to solve imperative problems and develop strategic thinking.



## 2. Competition Application

### 2.1 Participation Requirements

Participants: Contestants shall participate in teams, the number of contestants is 2-4 for each team, with 1-2 mentor(s).

Age: Team members must be between the age of 8-15 (born between January 2, 2007 and December 31, 2015). The mentor must be at least 18 years old.

Team Roles: Everyone in the team can play their respective roles as operator, observer, mechanist, programmer and so on. In each competition, one team can only appoint 1 operator and 1 observer to participate. Each alliance includes 2 operators and 2 observers, and one of whom is designated as the captain of the alliance. The operator is responsible for operating the robot, and the observer is responsible for assisting the operator in observing the status of props and making suggestions.

Identification Symbols: Each team must have a team logo, team name, and team slogan. Teams are encouraged to use uniforms, flags, posters, badges, base decorations, etc. to show the team culture.

### 2.2 Registration and Application

Contestants and mentors that meet participation requirements can register on the designated competition webpage on MakeX official website ([www.makex.cc/en](http://www.makex.cc/en)). Each team should register with one registration form.

If participating team wants to change their members before competition, which leads to inconsistency with the registration information, they should inform MakeX Robotics Competition Committee in advance to finish re-registration.

For more details about the registration and application, please refer to [MakeX Registration & Competition Application Guide](#)

## 3. Competition Procedure

Participating teams shall pay close attention to related notices and Competition Guide published before each competition. If the rules have some updates in competition guide, the latest rules will be adopted for the competition. MakeX Competition Committee reserves the rights and final interpretation to amend competition rules and system based on actual situation of different competition.

The schedule for each competition is determined by actual situation, and generally

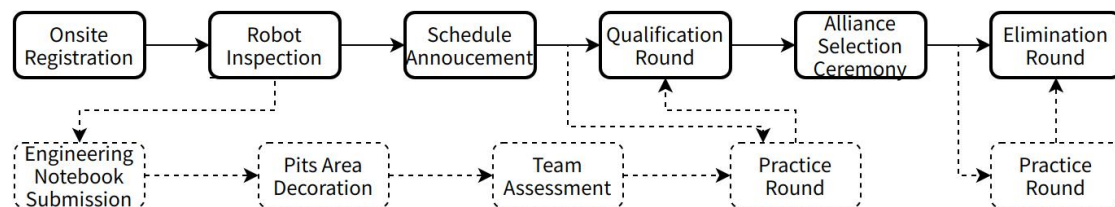

includes following procedures.

\* Note: The solid line frame refers to the necessary procedure of each match, while the dotted line frame refers to non-essential procedure. The specifications of non-essential procedures can be understood based on **Appendix 6 Supplementary Explanation of Competition Procedure**. Please keep abreast of updates.

### Onsite Registration

When a team arrives at the venue, mentors and contestants should show ID cards or other valid certificates (e.g., passport) for onsite registration and to get the competition material pack. Mentors must inform team members about the fire exit, match schedule, arena, pits area, etc. Onsite registration and robot inspection will be closed once the match schedule is announced.

### Robot Inspection

The inspectors will strictly check the safety of robots on request. Teams can pre-check their robots in advance based on "**Appendix 3 MakeX Explorer**





**Eco-Pioneer Robot Self-Check Form"**. The robot and self-customized environmental flag will be inspected before competition. If the inspection fails, the team needs to adjust their robots and check again until they pass the inspection. Those who fail to pass the inspection are not qualified for the competition.

### **Schedule Announcement**

The committee will announce the match schedule at least 30 minutes ahead of competition through online official website and onsite announcement. The schedule includes match-up chart, match session and specific time, red alliance and blue alliance, etc.

### **Qualification Round**

Normally, each team is requested to participate in four matches during qualification round. However, the session of qualification round may be different based on different competition. In qualification round, red alliance and blue alliance are matched randomly. Points will be obtained by teams according to the winning or losing result. It is conducted in the form of alliances confrontation and each team's alliance and the opponents will be allocated randomly.

In each qualification round, team will receive corresponding points (including win, tie, loss) regardless of competition type. Three points for a win, one point for a tie, and no point for a loss. The final ranking is based on the sum of win-loss points, and the top-ranking teams will be promoted to the elimination round. If the team with the same win-loss points, the ranking sequence will be determined according to following rules:

- 1) The team with a higher total points differential of all qualification rounds has a higher ranking.
- 2) If the above conditions are the same, the team with higher total scores among all qualification rounds has a higher ranking.
- 3) If the above conditions are the same, the team with the highest score of a



single round in all qualifications round has a higher ranking.

- 4) If the above conditions are same, teams with the same ranking will play a one-on-one extra match, and those who with the highest total points will be the winner.

### **Alliance Selection Ceremony**

In alliance selection ceremony, promoted teams will select their alliance team in turn according to their ranking in qualification round. During this procedure, teams must abide by following rules:

When being chosen by other teams, promoted teams ranking top 50% can refuse for only once, and those teams ranking bottom 50% cannot refuse. If the team is refused by another team, they can continue to choose another team until the alliance is formed.

The promoted teams who are not present before the start of alliance selection are deemed as voluntarily giving up the right to choose alliance, and those who are not present before the end of the alliance selection are considered to be as voluntarily quitting the elimination round. If the promoted teams quit amid the alliance selection ceremony, the promotion places will be given to the following teams according to the ranking in the qualification round.

The promotion proportion for 2022-2023 season competition is as follows. However, the promotion quota in different competitions may be different according to actual situation.

| Number of participating teams | Number of promoted teams |
|-------------------------------|--------------------------|
| 121 or more                   | 64                       |
| 65-120                        | 32                       |
| 32-64                         | 16                       |
| 12-31                         | 8                        |



## Elimination Round

In elimination round, the alliance generated in the alliance selection will be the opponent (red alliance and blue alliance are automatically matched). The winner will be evaluated by BO3(Best of 3) and the alliance who achieve "two wins" or "one win and two ties" can advance to next round until the champion, runner-up and second runner-up are elected.

If the alliance achieves "1 win, 1 loss, 1 tie" or "3 ties" in three rounds, the winning alliance will be decided according to the following rules:

1) If win-loss points are the same, team with higher total point differential in BO3 has a higher ranking.

2) If above conditions are the same, team with highest scores in BO3 has a higher ranking.

3) If above conditions are the same, teams will play an extra match until the winner is elected.

Taking the promoted 32 teams as an example, the schedule of elimination round is as follows:

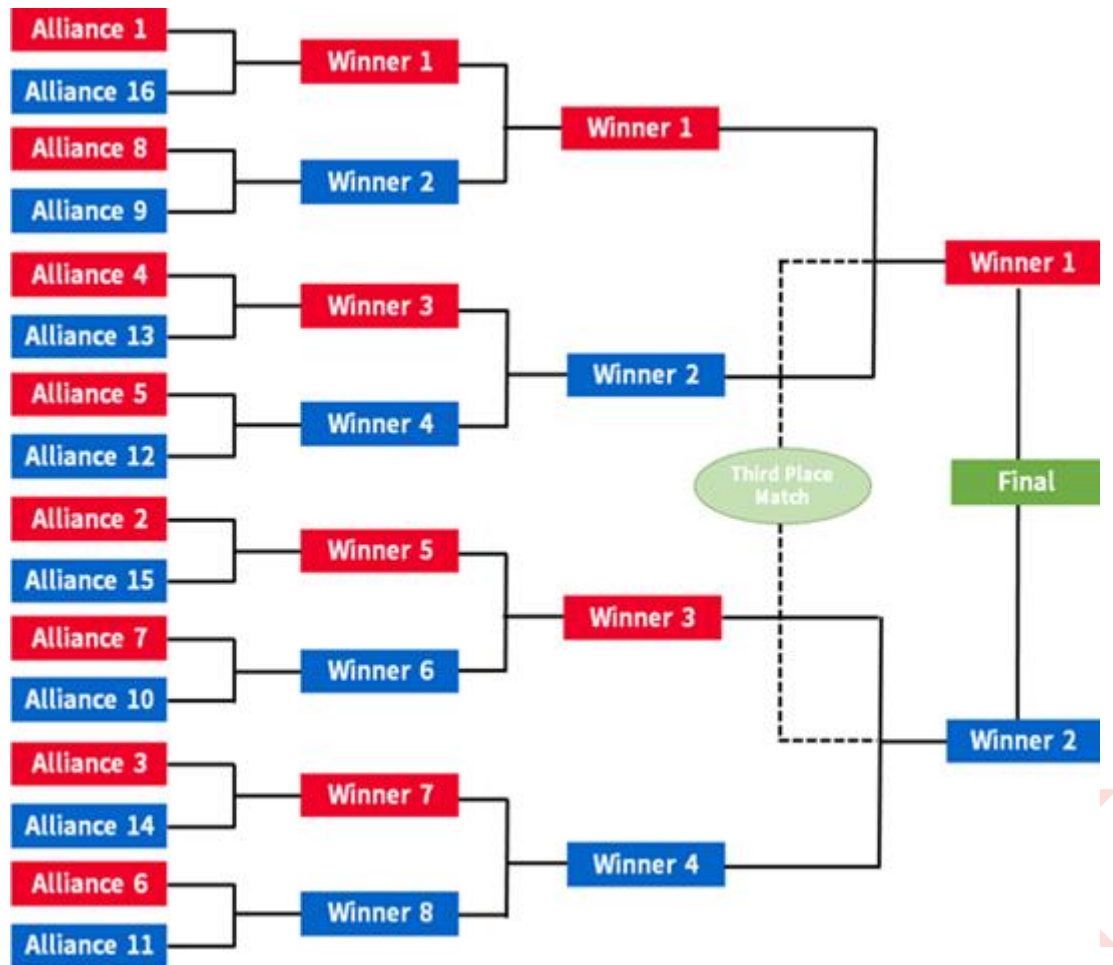



## 4. Competition Details

The theme of the 2022-2023 MakeX Explorer is "Eco-Pioneer".

In the past century, high emissions of carbon dioxide, water vapor, nitrous oxide, methane, and other greenhouse gases have led to the rapid increase in Earth's temperature. In addition to actively reducing greenhouse gas emissions, the solution to global warming is also proven effective by using advanced equipment to capture carbon dioxide. The collected carbon dioxide can be further used in chemical production, sustainable fuel production, agriculture, and medicine to reduce greenhouse gas emissions, slow climate warming, and ultimately achieve the goal of sustainable development.

### 4.1 Introduction

MakeX Explorer is a confrontational competition, among which red and blue alliance for each match, and two teams for each alliance.

Each match comprises automatic stage and manual stage. Teams are required to control the robot to finish missions in an automatic or manual manner. At the end of the competition, the referee will calculate all of the mission points for both teams, and the alliance with the higher score will be the winner.

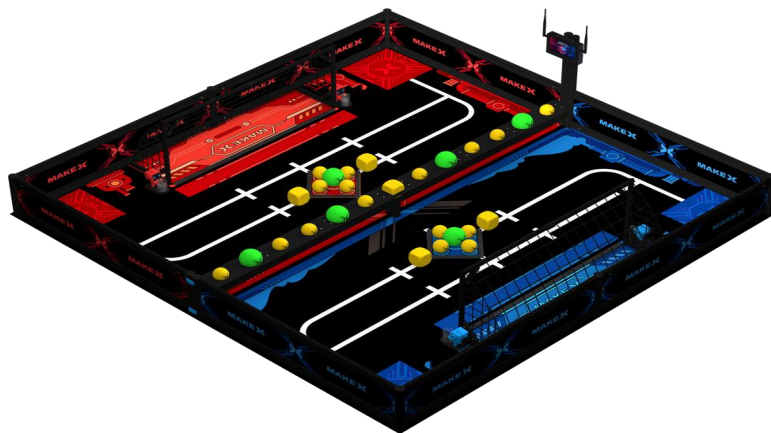

Fig 4.1 Axonometric View of the Arena



## 4.2 Arena

The arena of MakeX Explorer is a rectangular area with the size of 2440 mm × 2440 mm, which is composed of a map and frames. The map is measured by 2317mm × 2357mm and the frame is 255mm in height and 15mm in thickness. The arena mainly consists of CO2 emission zone (central area), starting area, CO2 conversion area (goal area), max cylinder, anti-leakage device area and manufacturing area and flag placement area.



Fig 4.2-1 Arena Illustration

The competition arena is divided into red camp, blue camp and central area. Robots are only allowed to finish corresponding missions in individual camp.



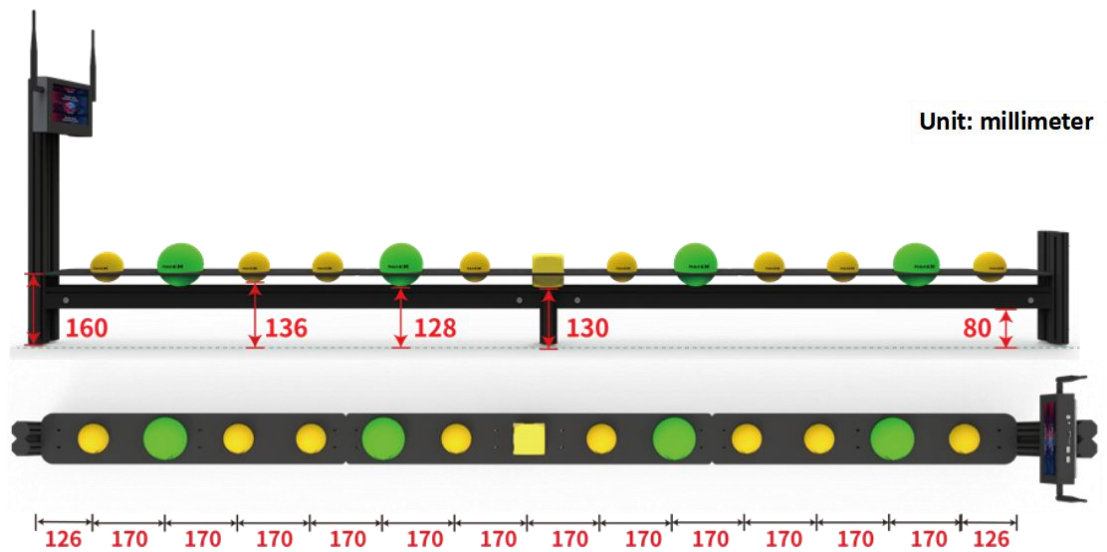

Fig 4.2-3 CO2 Emission Zone (Central Area)

**Starting Area**

With the size of 320mm × 320mm, the starting area, four corners of the arena, is where robots are placed before the competition. There are two starting areas for red alliance and blue alliance.

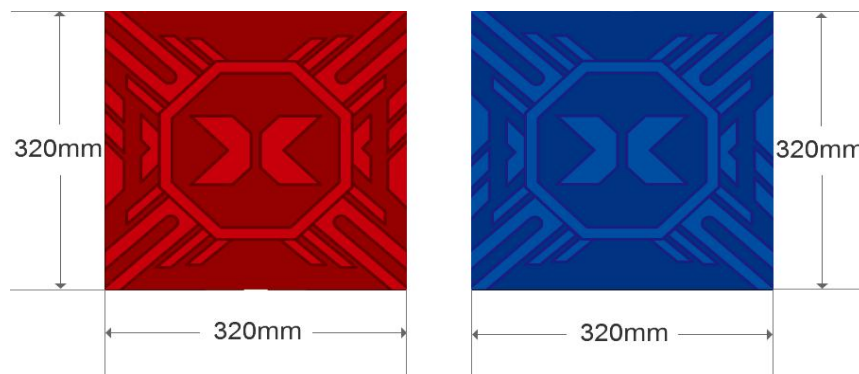

Fig 4.2-4 The Starting Area

**CO2 Conversion Area (Goal Area)**

There is one CO2 Conversion Area (Goal Area) for red alliance and blue alliance. The goal area is composed of metal beams and black net. There is a foam threshold in front of the goal area, with metal beams pasting on the Velcro paste area.

Net state description: The inner side of the net is fixed to the metal beam with strips





and the outer side of the net is pressed down with an arena frame. Once the net is constructed, and the net drops naturally.

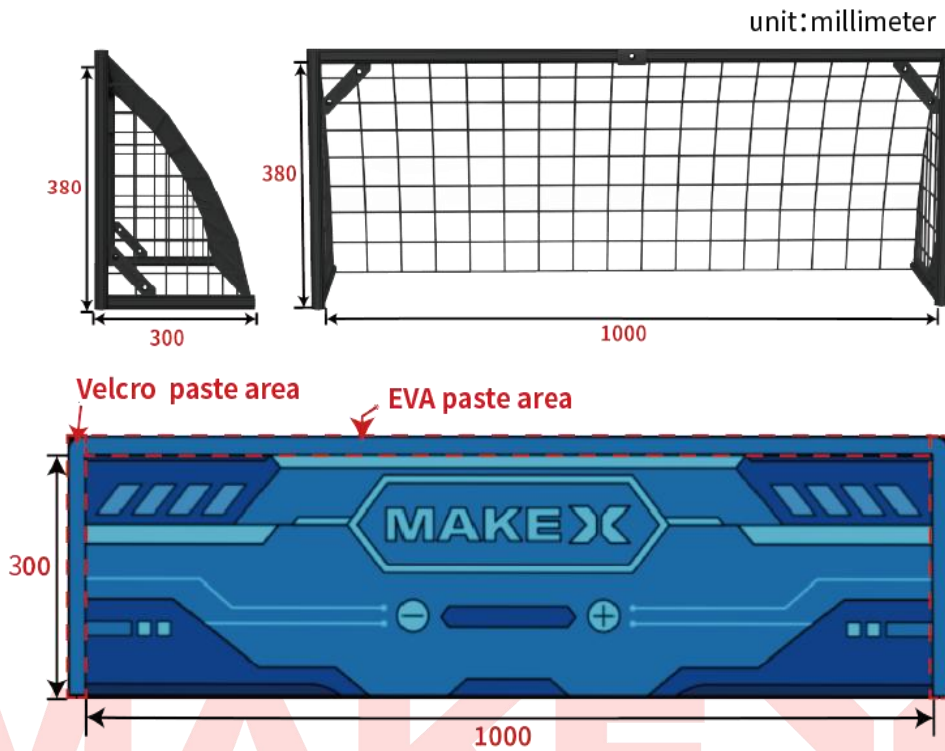

Fig 4.2-5 The Goal Area

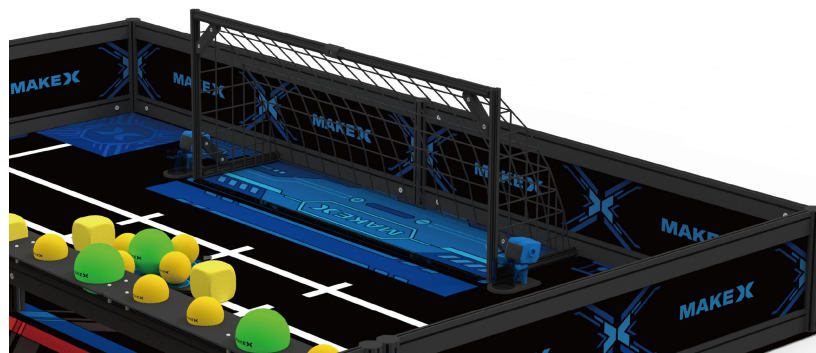

Fig 4.2-6 Axonometric View of the Goal Area



### Max Cylinder

There are two Max Cylinders for red alliance and blue alliance respectively. Max Cylinder is composed of max (model), cylinder and pedestal. Max and cylinder are fixed on the cylinder pedestal with screws, while the pedestal is attached to the map with Velcro. The cylinder is 46mm long in inner diameter and 58mm in height.



Fig 4.2-7 Max Cylinder

### Anti-Leakage Device Area (Device Area)

Anti-Leakage Device Area (Device Area) is a rectangular area in the front of the goal area, with the size of 1070mm × 100mm. There is one device area for red alliance and blue alliance.

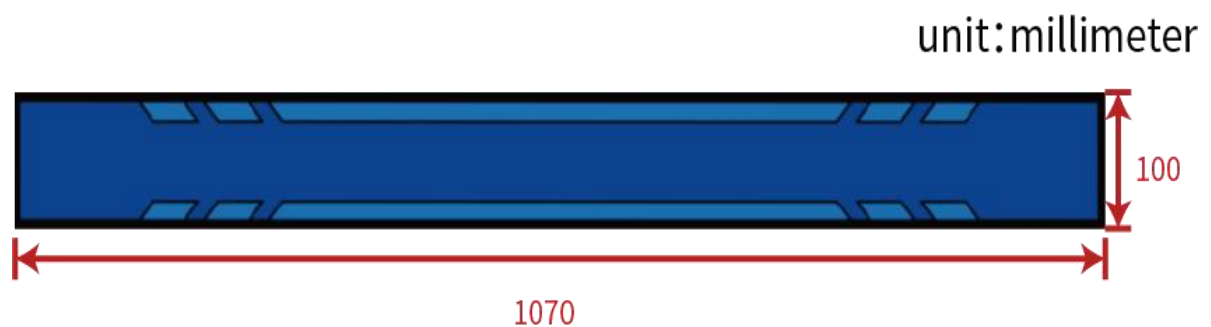

Fig.4.2-8 Device Area

## Manufacturing Area

There is one manufacturing area for red alliance and blue alliance respectively, which includes diamond-shaped area and cube wireframe. Anti-leakage device (yellow cube) and carbon capture container (ball) are placed in the manufacturing area. There is an area in 10mm width around the diamond-shaped area for pasting Velcro. Anti-leakage devices will be placed randomly in two of four cube wireframes by drawing prop card before the match.

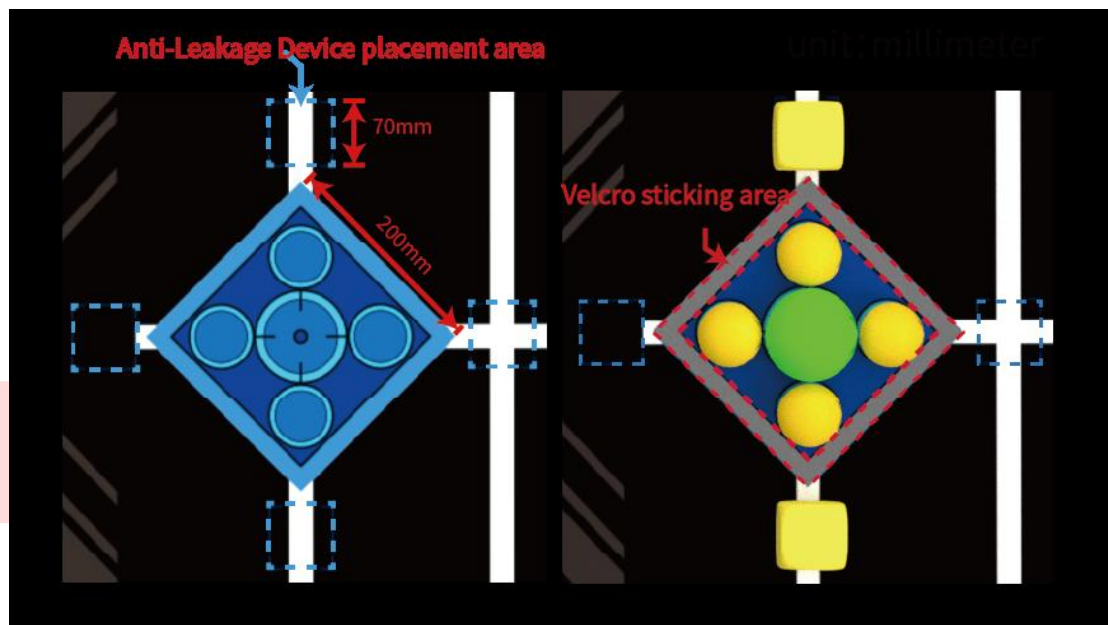

Fig.4.2-9 Manufacturing Area

## Flag Placement Area

The red and blue camps each have 2 flag placement areas, which are square wire-frame areas near the sides. There are 4 flag placement areas in total for teams to place their self-made flags, 2 for each alliance. Before the start of the competition, contestant must place their own flags in this area; the bottom side of the flags must be completely inside this area and in an upright position.

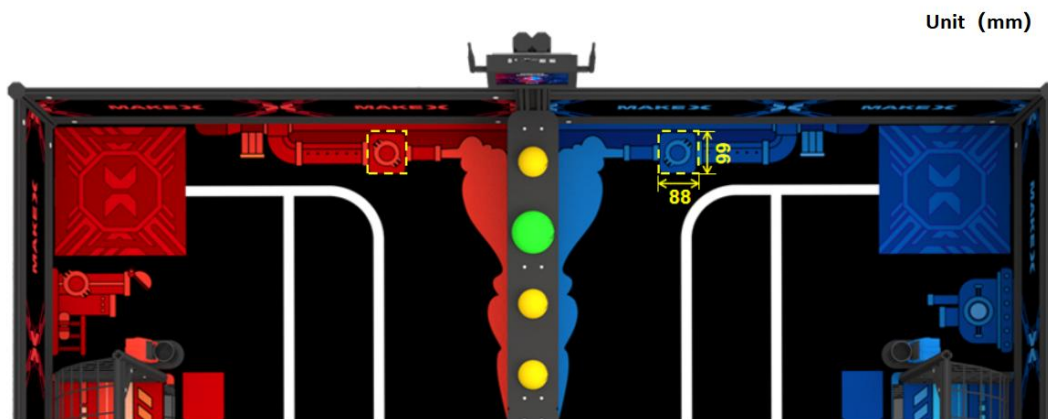

Fig.4.2-10 Flag Placement Area

### 4.3 Lists of Props

#### Carbon Capture Container (Ball)

There are two types of ball, representing different sizes of carbon capture containers. The initial position is in the central area and manufacturing area. These balls are made of EVA, including sixteen small yellow balls and six large green balls. The diameter of small yellow ball and large green ball is 70mm and 100mm respectively.

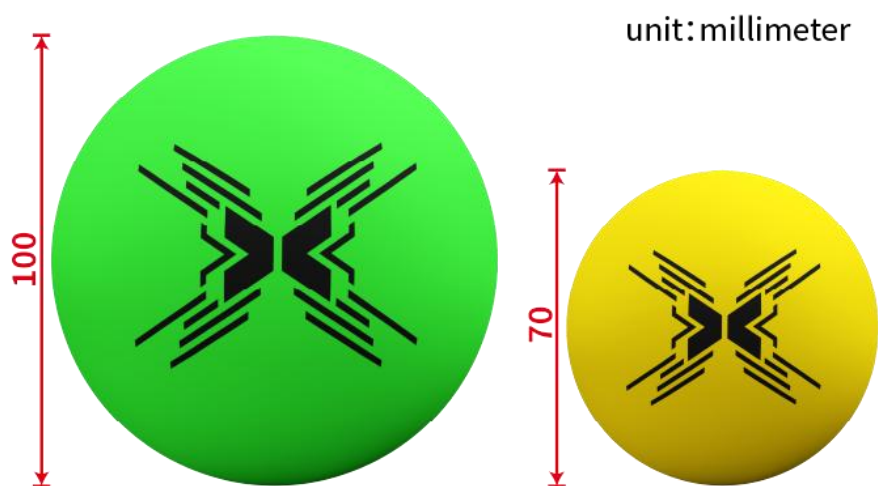

Fig.4.3-1 Carbon Capture Container (Ball)

#### Anti-Leakage Device (Cube)

The yellow cube represents the anti-leakage device, with the side length of 70 mm. There are five EVA cubes in the arena, among which two cubes are in respective



manufacturing area, one cubes in the central area.

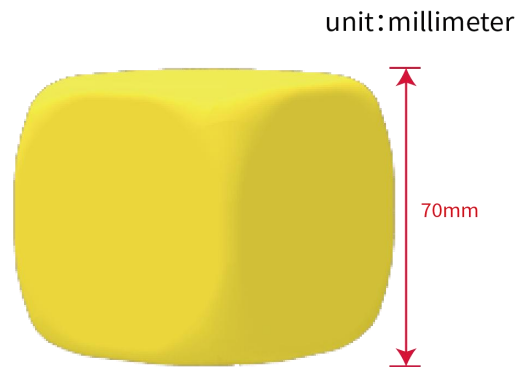

**Fig.4.3-2 Anti-Leakage Device (Cube)**

**Environmental Flag**

The environmental flag is a team self-made prop composed of a flag and a flagpole, it's allowed to have a pedestal and the pedestal can't be separated from the flagpole. The size of the environmental flag surface is no less than 80mm × 60mm. The size of the flagpole (and pedestal if any) is smaller than 30mm\*30mm, with the length no less than 100mm. Please refer to "5.2 Specifications for Environmental Flag" for the details.

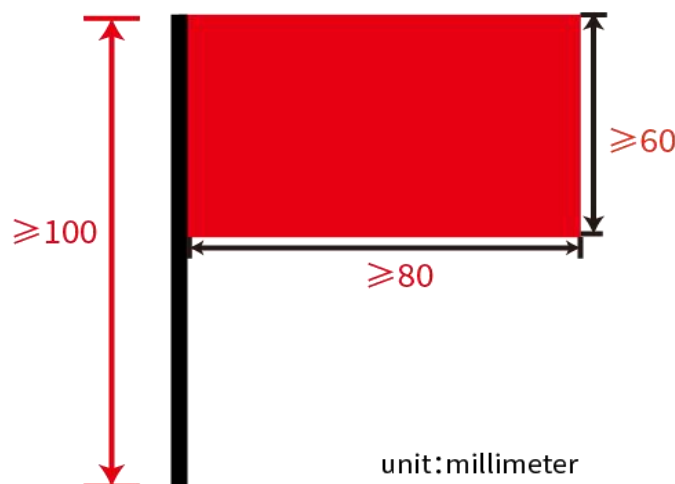

**Fig.4.3-3 Environmental Flag**

\* Note: All areas and props have certain tolerances. If there are any objection to the



size of the props or other problems, the referee can determine whether to change according to the actual situation.

### 4.4 Missions Introduction and Scoring State Judgement

The competition lasts for 4 minutes, including automatic stage (30 seconds) and manual stage (210 seconds). Mission details of each stage are shown as follows. At the beginning and the end of each stage, the referee will remind the contestants by counting down. Please refer to "4.6 Single Match Flow" for the specifications.

| Stage and Time               | Missions                              | Mission Details  |
|------------------------------|---------------------------------------|--|
| Automatic Stage (30 seconds) | Installing Anti-Leakage Device        | Running automatic program to make the cube in manufacturing area enter respective device area;                     |
|                              | Transferring Carbon Capture Container | Running automatic program to make the ball in manufacturing area enter opponent's goal area;                       |
|                              | Inserting Environmental Flag          | Running automatic program to insert environmental flag into respective Max Cylinder;                               |
| Manual Stage (210 seconds)   | Installing Anti-Leakage Device        | Controlling the robot to make the cube in individual camp or central area completely enter respective device area; |
|                              | Transferring Carbon Capture Container | Controlling the robot to make the ball in individual camp or central area enter opponent's goal area;              |
|                              | Inserting Environmental Flag          | Inserting environmental flag into respective Max Cylinder;   |

Fig.4.4 Competition Stage and Mission Introduction



### 4.4.1 Mission Name: Installing Anti-Leakage Device

**Mission Description:** This mission can be finished in automatic stage and manual stage.

In automatic stage, robots are required to run automatic program to make the cube in manufacturing area enter respective device area.

In manual stage, the contestants control the robot to make the cube in individual camp or central area completely enter respective device area.

**Scoring State Judgement:** At the end of the match, it can be scored if the cube is completely in the device area, and have no contact with the robot, which refers to the vertical projection of the cube is completely located in the device area. Forty points for successfully moving a cube into the device area. The maximum number of valid scoring cubes is 3.

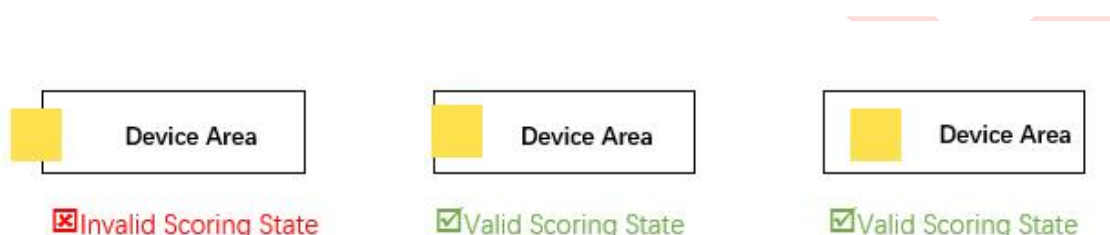

**Fig.4.4-1 Scoring State Judgment of Cube**

### 4.4.2 Mission Name: Transferring Carbon Capture Container

**Mission Description:** This mission can be finished in automatic stage and manual stage.

In automatic stage, robots are required to run automatic program to push or toss the ball in manufacturing area into opponent's goal area.

In manual stage, contestants are required to control the robot to push or toss the ball in individual camp or central area into opponent's goal area.

**Scoring State Judgement:** At the end of the match, it can be scored if the ball enters the goal area and meets one of the following two conditions:



1. The ball has direct contact with the map of the goal area, but has no contact with the map outside the goal area;

2. The ball has indirect contact with the goal area, and the vertical projection of the ball is completely in the goal area;

Sixty points for one large green ball; Thirty points for one yellow small ball.

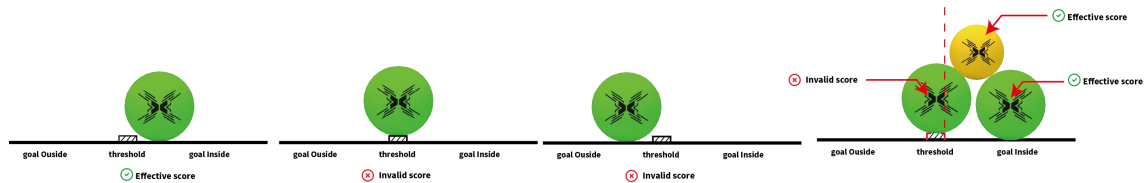

Fig.4.4-2 Scoring State Judgement of Ball - Side View

### 4.4.3 Mission Name: Inserting Environmental Flag

**Mission Description:** This mission can be finished in automatic stage and manual stage.

In automatic stage, robots are required to run automatic program to insert environmental flag into respective Max Cylinder.

In manual stage, contestants are required to control the robot to insert environmental flag into their respective Max Cylinder. Only one environmental flag can be placed in each Max Cylinder.

**Scoring State Judgement:**

The following situation is regarded as successful insertion of environmental flag: the flagpole must be in the Max Cylinder, while the flag surface and flagpole cannot have contact with the ground and robots. The flag is not allowed to lean on the other props either the net or the goalmouth, except for the Cylinder and Max. Fifty points for one environmental flag.



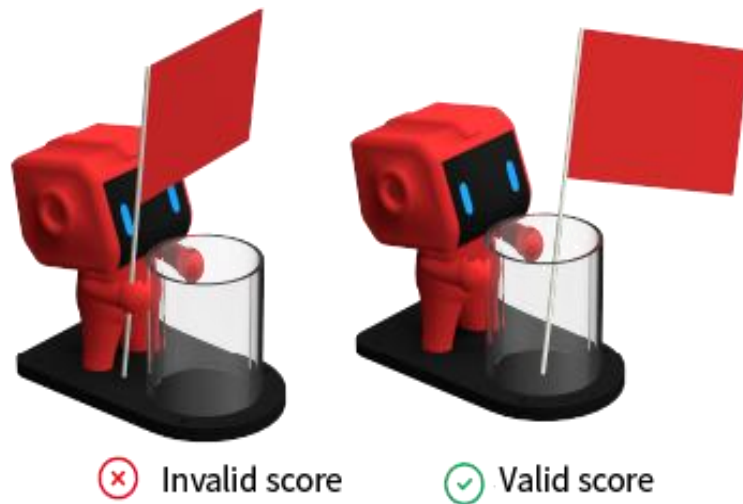

Fig.4.4-3 Scoring State Judgement of Environmental Flag

### Boundary State Judgement

During the match, if there is any uncertainty about the position of the robot (or props) and designated boundary, the following state judgement can be explained:



## 4.5 Scoring Explanation

The final score of the competition is determined by the final static state of the scoring prop after the competition. Competition missions, scoring props and its corresponding points are as follows. After the competition, the referee calculates the sum of scores of each mission, and the alliance with the higher score will be the

winner.

Alliance points of single match= cube points + large ball points + small ball points+ environmental flag points - penalty points

| Mission                               | Scoring Props      | Point of Single Prop | Max Number of Single Prop | Maximum Mission Point |
|---------------------------------------|--------------------|----------------------|---------------------------|-----------------------|
| Installing Anti-Leakage Device        | Cube               | 40 Points            | 3 pieces                  | 120 Points            |
| Transferring Carbon Capture Container | Large Ball         | 60 Points            | 6 pieces                  | 360 Points            |
|                                       | Small ball         | 30 Points            | 16 pieces                 | 480 Points            |
| Inserting Environmental Flag          | Environmental Flag | 50 Points            | 2 pieces                  | 100 Points            |

Fig.4.5 Mission and Corresponding Points

## 4.6 Single Match Flow

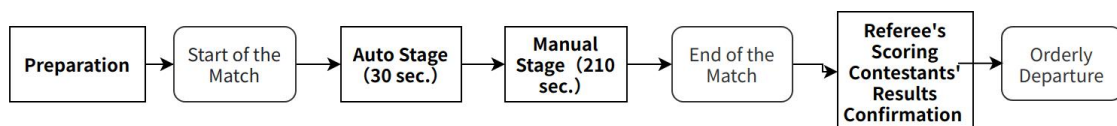

Fig.4.6 Single Match Flow Chart

### Preparation

Before the single match, contestants should arrive to the competition area ahead of schedule, and make preparations under the guidance of referee:

- 1) Power on the robot and place it in the starting area, with Bluetooth controller powering on and placing outside the arena.
- 2) One representative will be appointed by their team to draw a prop card and then place the cube accordingly;



- 3) Check the standard of arena and props placement of both alliances.

### **Automatic Stage**

The automatic stage begins after referee's five-second counting down.

- 1) Contestants are not allowed to touch the robot after running automatic program.
- 2) Before the end of automatic stage, robots are required to complete the automatic program and remain stationary. Besides, robots do not need to return to the starting area.
- 3) It is not allowed for robots to rob or directly touch the props in the central area, they are only allowed to use respective props to complete the mission. Please refer to "**6.2 Competition Rules-Operation Rules**" for the specifications.

The automatic stage ends after referee's five-second counting down.

### **Manual Stage**

The manual stage begins after referee's five-second counting down.

- 1) Contestants control the robot with Bluetooth controller;
- 2) The manual stage ends after referee's five-second counting down. After manual stage, contestants must put down the Bluetooth controller to stop robot controlling.

### **Referee's Scoring and Contestant's Results Confirmation**

The referee will count the scores after the competition. If there is no objection to the competition, the captains of both alliances must confirm the match's result. If there is any doubt about the result, the captain of the alliance may appeal to the referee without signing the score sheet.

After results confirmation, contestants shall actively assist the referee to restore the props, and leave the competition area with their robots and Bluetooth controller in an orderly manner.



## 5. Technical Specifications

### 5.1 Specifications for Robot Construction

The specifications for robot construction are designed to create a fair competition rule that ensure the participation safety. The committee encourages teams to conduct hardware construction and software programming on the premise of observing the specifications. During the competition, it is a must for robots to abide by the specifications. Any robot that violates the specifications will be required to be modified. Those who commit serious offense will be punished for disqualify competition result or competition qualifications.

**T01.** Each team can participate in the match with one robot. It is not allowed for one robot to participate in the match, while the other to conduct construction and modification outside the arena.

**T02.** Except for mainboard, chassis, wheels and tracks that make the robot move on the flat are non-replaceable, contestants can replace other parts due to parts malfunction or competition missions.

**T03.** During the competition, the maximum extension size of robot shall not exceed 320mm\*320mm\*360mm (length \* width \* height). The maximum extension size refers to the size that the robot extends its mechanic limit during operation.

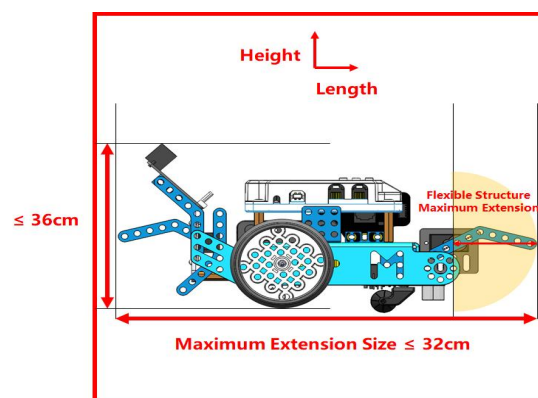

Fig 5.1-1 Maximum Extension Size -Side View

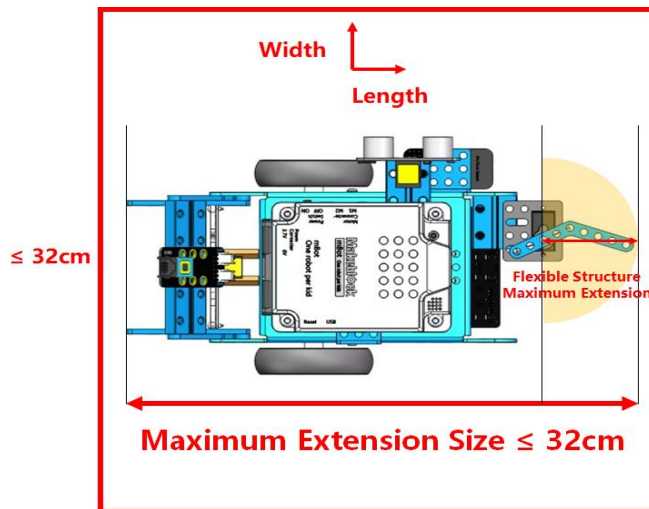
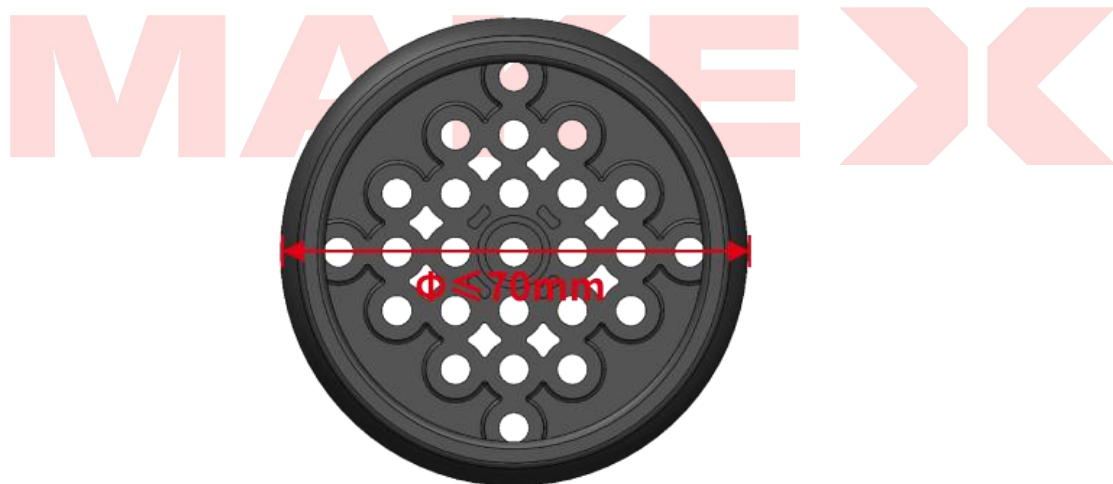

Fig 5.1-2 Maximum Extension Size -Top View

**T04.** During the competition, the maximum net weight of the robot shall not exceed 4 kg, including the weight of battery and excluding the weight of environmental flag.



**T05.** To ensure the fairness of the competition, the wheel diameter (included the Rubber tyre skin) must not exceed 70mm.

**T06.** The equipment with high performance that infringes the competition fairness is prohibited, which must be operated with following performance indicators:

| Equipment    | Component | Specification                                    | Note                         |
|--------------|-----------|--|------------------------------|
| Motor& Servo | DC motors | 1. High Speed TT Motor<br>● Rated Voltage: DC 6V | ● No more than 4 motors (DC) |



|  |               |   |   |
|--|---------------|---|---|
|  |               | <ul style="list-style-type: none"> <li>No-load speed :312RPM±10%</li> <li>Gear Ratio: 1:48</li> </ul> <p>2. 37 DC motors</p> <ul style="list-style-type: none"> <li>Rated Voltage: 12V</li> <li>Rated Speed: 50&amp;200RPM</li> <li>Rated Torque: 4.5Kg.cm&amp; 1.5Kg.cm</li> </ul> | <ul style="list-style-type: none"> <li>motors, encoder motor) are installed on the robot</li> <li>No more than 4 servos are installed on the robot</li> <li>It is forbidden to change the mechanical structure and electrical layout of any motor or servo</li> <li>Note: 37 Motor should be prepared by the team themself</li> </ul> |
|  | Encoder Motor | <p>1. 180 Photoelectric Encoder Motor</p> <ul style="list-style-type: none"> <li>Driving Voltage: DC 7.4V</li> <li>Speed Range: 7.4V0~350RPM±5%</li> <li>Rotation Accuracy: ≤5°</li> <li>Reduction Ratio: 39:43</li> </ul>  |   |
|  | Servo         | <p>1. MECDS-150 Servo</p> <ul style="list-style-type: none"> <li>Working Voltage: DC 6.0V</li> <li>Torque Peak: 16.5kg.cm</li> </ul> <p>2. MS-1.5A Servo</p> <ul style="list-style-type: none"> <li>Working Voltage: 4.8-6V DC</li> <li>Torque: 1.31-.7kg.cm</li> </ul>             |   |

**T07.** In order to prevent the team from using some high-performance electronic devices to damage the fairness of the competition, the main control electronic devices used by the team should not exceed the following performance indicators:

| System       | Module           | Specification   | Note  |
|--------------|------------------|---|---|
| Power System | Built-in Battery | <ul style="list-style-type: none"> <li>18650 Lithium Battery: 3.7V 2500mAh</li> </ul> | Only one built-in battery and one external battery are allowed, which |



|                                  |                         |  |  |
|----------------------------------|-------------------------|--|--|
|                                  | <p>External Battery</p> | <ul style="list-style-type: none"> <li>● 18650 Battery Pack</li> <li>✓ Battery Capacity: 2500Ah-8000Ah</li> <li>✓ Discharge Rate: 3-5c</li> </ul>  | <p>are required to securely fastened inside the robot</p>  <p>Fig. External Battery Pack</p> |
| <p><b>Controlling System</b></p> | <p>Mainboard</p>        | <ul style="list-style-type: none"> <li>● Processor: Highly Integrated ESP32-WROVER-B</li> <li>● Dominant Frequency: 240MHz</li> <li>● Working Voltage: 6V ~ 13V (The minimum input voltage of motor is required to meet the requirement of motor's working voltage.)</li> <li>● Communication Ports and Protocols: Serial Port/mBuild Protocol</li> </ul>  | <p>Only one mainboard is allowed</p>   |
|                                  | <p>Extension Board</p>  | <ul style="list-style-type: none"> <li>● Micro Processor: GD32F403</li> <li>● Input Voltage/Current: 5V 2000mA (Rapid Charging) 5V 500mA (Simultaneous using and Charging)</li> <li>● Communication Mode: <ul style="list-style-type: none"> <li>✓ Serial Communication: Mainboard to Extension Board</li> <li>✓ Digital Signal: Digital Servo Interface</li> <li>✓ PWM: DC Motor Interface</li> </ul> </li> </ul> |  |



|                                       |                             |   |  |
|---------------------------------------|-----------------------------|---|--|
| <p><b>Sensor System</b></p>           |                             | <ol style="list-style-type: none"> <li>1. Vision Sensor                     <ul style="list-style-type: none"> <li>● Viewing Angle: 65.0 degrees</li> <li>● Effective Focal Length: 4.65±5% mm</li> <li>● Identification Speed: 60 frames/seconds</li> <li>● Identification Distance: 0.25-1.2m is the best range</li> <li>● Method of Power Supply: 3.7V Lithium Battery or 5V build Power Module</li> <li>● Power Consumption Range: 0.9-1.3W</li> </ul> </li> <li>2. Ultrasonic Sensor                     <ul style="list-style-type: none"> <li>● Working Voltage: DC 5V</li> <li>● Distance Range: 5-300cm</li> <li>● Tolerance of Distance: ±5%</li> </ul> </li> <li>3. Line Finder Sensor                     <ul style="list-style-type: none"> <li>● Working Voltage: DC 5V</li> <li>● Detected Height: 5mm-15mm</li> </ul> </li> </ol> | <ul style="list-style-type: none"> <li>● Type and quantity are not limited</li> <li>● It is forbidden for robots to use any sensors that will interfere with the perception ability of other robots</li> </ul> |
| <p><b>Wireless Control System</b></p> | <p>Bluetooth Controller</p> | <ul style="list-style-type: none"> <li>● Bluetooth Version: Support 4.0+</li> <li>● Distance of Remission: 20m</li> <li>● Working Current: ≤25mA</li> <li>● Transmit Power: 4dBm</li> <li>● Transmit Data: Data packets within 100ms can be acquired by Bluetooth devices (low latency)</li> <li>● Battery: Two No.5 AA Dry Batteries</li> <li>● Supported Platform: macOS / Windows</li> </ul>   | <ul style="list-style-type: none"> <li>● During the competition, one Bluetooth controller is available for one team.</li> </ul>  |





|  |                  |  |   |
|--|------------------|--|---|
|  | Bluetooth Module | <ul style="list-style-type: none"> <li>● Bluetooth Version: BT4.0</li> <li>● Band Range: 2402~2480MHz</li> <li>● Antenna Gain: 1.5dBi</li> <li>● Energy Consumption Grade: ≤4dBm</li> <li>● Working Current: 15mA</li> </ul> | It is forbidden to use any form of wireless control device to communicate with robots other than the official Bluetooth controller, including but not limited to any artificially triggered sensors |
|--|------------------|--|---|

**T08.** If the robot uses a laser sight, the power of the laser sight must be less than or equal to 5mW (grade 3 A /R below). Each robot is allowed to install no more than one laser sight.

**T09. Teams are not allowed to build robots using multi-DOF commercial products:**

- Including but not limited to multi-DOF manipulator, manipulator, etc.
- Metal and plastic structural parts are not included.

**T10.** The following robot's parts that may cause danger are forbidden:

- Sharp angle;
- Oil pressure parts or hydraulic parts;
- Switches or contacts containing mercury;
- Parts that will conduct electrical current from robots to arena;
- Parts that tend to develop connections with other robots, such as hook-shaped parts and other parts;
- Other dangerous parts as determined by the judges.

**T11. The following materials that may cause danger are forbidden:**

- Flammable and explosive gases;
- Materials containing liquids or gelatinous substances (except for glues and lubricants used in prescribed and small quantities);
- Materials that may cause arena contamination, such as sand, ink, etc.;

- Materials made from animal tissue;
- Materials that may cause danger as determined by other referees.

## 5.2 Specifications for Environmental Flag

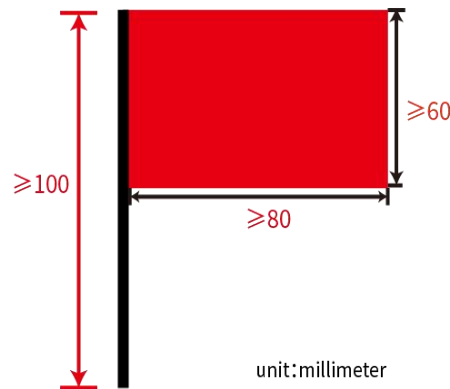

Fig 5.2 Environmental Flag

- The environmental flag is a team self-made prop composed of a flag and a flagpole, it's allowed to have a pedestal and the pedestal can't be separated from the flagpole.
- The size of the environmental flag surface is no less than 80mm(length) × 60mm(wide).
- The shape of flagpole and pedestal is unlimited. The vertical projection of this part should not exceed 30mm\*30mm, with the length no less than 100mm.
- The surface of the flag should be made with fabric, paper or other flexible materials, and it has to be in an extended state during the competition.
- The flag that meets the rules requirements at all times of the competition is allowed to participate in the competition.
- At most one flag for per team.

The Committee encourages teams to draw personalized patterns or words on the flag, which calls for positive content reflecting competition theme and spirit, without showing words or pictures related to MakeX Robotics Competition Committee.



## 6. Competition Rules

### 6.1 Penalty explanation

#### Verbal Warning

**E01.** The referee gives the team a verbal warning of the first violation and asks them to stop any violation and obey the referee's instructions (Each team in every single match have only one chance of verbal warning). In the meantime, no points will be deducted and the competition will not pause.

#### Violation

**E02.** The referee issues a violation to the violation team, and immediately deducts 20 points. In the meantime, the competition will not pause.

#### Yellow card

**E03.** If any contestants' behavior seriously affects the competition fairness or violates the safety rules, the team or alliance will receive a yellow card with 60 points deductions.

Yellow Card Accumulation:

If a team receives a yellow card, 60 points will be deducted from its team or alliance.

During one match, two accumulated yellow cards will be upgraded to a red card, and its robot will be suspended.

During the qualification round, yellow cards are accumulated by teams. While in the elimination round, yellow cards are accumulated by alliances.

#### Suspension

**E04.** The referee issues a suspension to ask the robot to stop its action. Besides, the referee is entitled to whether to remove the suspended robot out of arena based on specific condition.



The contestants shall ask the referee to suspend the robot while encountering robot malfunction and uncontrollability.

### **Red Card**

**E05.** If any side or its members' behavior seriously affects the competition fairness or violates the safety rules, the alliance will receive 120 points deductions, and its robot will be suspended. The referee is entitled to whether to remove the suspended robot out of arena based on specific condition.

Penalty of Red Card:

Qualification Round: Take team as unit. If one team of alliance receives a red card, the team will receive 120 points deduction and the team's robot will be suspended, in the meanwhile the match will continue as usual. If both teams of alliance receive red card, the alliance will receive the points deduction and lose the competition. (If the score of losers is higher than the winner, the winner will receive extra 10 points higher than the final score of the loser)

Elimination Round: Take alliance as unit. If the alliance receives red card, the alliance will lose in the match. (If the score of losers is higher than the winner, the winner will receive extra 10 points higher than the final score of the loser)

### **Disqualify Single Match**

**E06.** During the match, the team violated the rules, the robot will be suspended immediately and resulting in invalidate of the score of the match, but did not affect the other matches.

### **Disqualify Entire Competition**

**E07.** The robot will be suspended immediately and the team cannot participate in the competition and the following competition, all result will be disqualified. The team will lose the opportunity to continue to participate in the competition and the right to award.



## 6.2 Operation Rules

### Destructing or Contaminating Arena

**R01.** Robots are not allowed to maliciously "climb" or "collide" the boundary of the arena and the central partition.

- The robot that violates the rules will be suspended. Team with two violations will be disqualified entire competition.

**R02.** If arena contamination is caused by the robot, the robot will be regarded as in an unsafe state. Robots are not allowed to use double-sided tape or glue or any other materials to fix arena elements during competition.

- The robot that violates the rules will be suspended. Team with two violations will be disqualified entire competition.

### Destructing Other Robots

**R03.** Robots are not allowed to collide with other robots during competition.

- The robot that violates the rules will be suspended. Team with two violations will be disqualified entire competition.

### Robots Out of Boundary

**R04.** Any parts of robot are not allowed to go beyond the arena boundary. The robot that goes beyond the boundary must return to its own area within three seconds and the referee will give a countdown reminder.

- The team who couldn't return to its own camp on time will be given a violation. Team with two violations will be disqualified for single competition.

### Using Banned Materials

**R05.** The following hazardous materials or dangerous structures embedded in robot are forbidden, such as:



- (1) Flammable gases, fire or smoke generating equipment, hydraulic oil or hydraulic parts, switches or contacts containing liquid mercury (mercury);
- (2) Hazardous Substances (e.g., Lead);
- (3) Materials that may cause arena contamination, such as sand and other objects that may be scattered during competition;
- (4) Materials that may have fixed connection with other robots;
- (5) Materials with sharp edges that may cause injury.
- (6) Materials made from animal tissue (for health and legal consideration).
- (7) Materials containing liquids or gelatinous substances (except for glues and lubricants that use as required).
- (8) Parts that can conduct electrical current from robots to any other parts in arena.
  - The robot that violates the rules will be suspended. If the robot continues to be a participant, contestant should modify it to accept re-inspection. Team with two violations will be disqualified entire competition.

### Other Unsafe Factors

**R06.** In addition to R05, referees are entitled to decide whether the robot is safe or not.

- The robot that violates the rules will be suspended. The robot needs to be modified and re-inspected before it can be back to the match. Team with two violations will be disqualified entire competition.

### Contestants' Requirements

**R07.** One operator and one observer for each team. Each alliance includes two operators and two observers, one of them is selected to be the captain of the alliance.

**R08.** It is not allowed for a third person as a substitution of on-arena players. Operators are responsible for controlling the robot in each match. The operator and



the observer can freely switch their roles during the match.

**R09.** Contestants should tie up their long hair during competition preparation, robot debugging and on match. Toe-baring shoes are forbidden.

- Team or alliance that violates the rules will be disqualified single match. The team need to re-adjust and have a re-inspection before come back to the match. Team with two violations will be disqualified entire competition.

#### **Can't Arrival the Arena on Time**

**R10.** Teams should arrive on time. Team that not show up in the competing area more than 5 minutes, will be treated as give up this match voluntarily. If the whole competition schedule is delayed, please refer to the specific notice.

- Penalty for this behavior: Disqualify the single match.

#### **Contestants' Standing Position**

**R11.** Contestants shall stand in certain range as shown in the following figure (the size of the operating area is subject to actual conditions).

- The team will receive a verbal warning, and those who commit a second offense will receive a violation. Contestants with serious offense will be disqualified for single match.

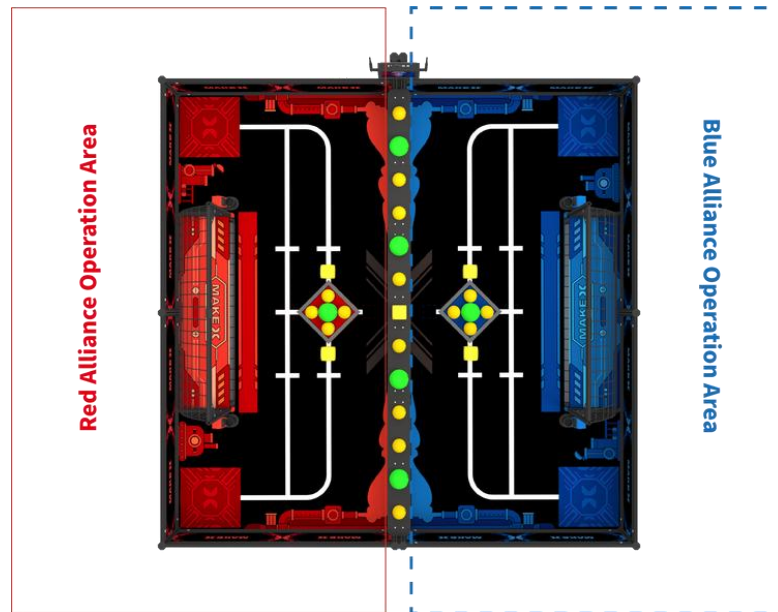

Fig. 6.2 Contestant's Standing Position

### Rules of Elimination Round

**R12.** During the elimination round, after the end of each match, each alliance has 5 minutes for debugging their robot and cannot overtime.

- The team will receive a verbal warning, and those who commit a second offense will receive a violation.

### Operating the Robot in Advance

**R13.** Robots are not allowed to operate until referee's announcement to start the competition.

- The team will receive a violation, and those who commit a second offense will receive a yellow card.

### Delay the end of the Competition

**R14.** After the end of automatic stage and manual stage, operator should stop controlling the robot or stop robot's operation program (except for the motion caused by inertia).

- The team will receive a violation. If the delay in ending competition gives the





offending team a scoring advantage, the referee shall judge it as an invalid score and the offending team is required to restore the arena to its original condition.

### **Bringing Banned Electronic Device**

**R15.** It is not allowed for contestants to bring electronic communication devices (mobile phone, transceiver, computer, wireless network devices and etc.) into the competition area except for prescribed devices.

- The team will receive a violation for the first time, a yellow card for a second time. Those who commit serious offense will be disqualified for single match.

### **Using Bluetooth Controller in Automatic Stage**

**R16.** Bluetooth controller should be connected with robot before the match. During the automatic stage, the blue-tooth controller should be place outside the arena; contestants are only allowed to pick up their blue-tooth controller after the automatic stage; after the manual stage, contestants must stop controlling their robot immediately.

- The team will receive a violation. The team that uses blue-tooth controller during the automatic stage will receive a red card. Those who commit serious offense will be disqualified for single match.

### **Operating Suspended Robot**

**R17.** The operator is not allowed to control the robot after the robot is suspended.

- The team will be disqualified for single match.

### **Robot's Left-Behind Components**

**R18.** During the competition, the following situation is forbidden, such as detachment of robot and its component and left-behind mechanical devices (detachment refers to detachment of robot ontology and its components). This rule is exception to the shedding caused by collision of opponent's robot or direct contact



with other robots.

- The team will receive a violation in case it affects the progress of the competition. Team with two violations will be given a yellow card.

### **Robot In-conformity during the competition**

**R19.** The size of the robot should in the state that approved by both teams and the referees before the competition. Robots must comply with the size, weight and other parameters specifications during the match. Except for those situations that are caused by non-subjective factors, including being hit by opponents' arena element or other external forces, which leads to robots deforming or oversized.

- The team will receive a red card.

### **Toss in Violation**

**R20.** Robots are not allowed to toss arena elements that are not allowed to toss (such as cubes, left-behind mechanical devices, flag, etc.) to opponent's camp.

- The team will receive a yellow card. The arena elements need to be restored if it causes any changes of arena elements in the opponent's side.

### **Difficult Detachment of Arena Elements and Robots**

**R21.** The robot shall be designed to easily remove competition elements from any inherent mechanical structure that is available to grab. Even if the power supply is suspended or turned off, robots can be taken out of arena on the premise of arena intactness.

- The robot that violates the rules will be suspended. The robot needs to be modified and re-inspected before it can be back to the match. Team with two violations will be disqualified entire competition.

### **Enter Opponent's Camp**

**R22.** During the competition, the vertical projection of the robot' s chassis shall not partially or completely enter the opponent's area in any form. The violation may be



upgrade if the partially enter will restrict opponent robot's moving.

- The team will receive a yellow card. The robot that enters the opponent's area must return to its own area within three seconds and the referee will give a countdown reminder.

### **Restricting the Movement of Opponent's Robot**

**R23.** Robots are not allowed to prevent the robot of opponents' alliance from moving in all directions or touching arena elements.

- The team will receive a violation, and those who commit serious offense will receive a yellow card.

### **Contact in Violation**

**R24.** In automatic stage, robots must finish the mission with individual props rather than grabbing or directly touching the props in central area.

- Those who maliciously grab the ball in central area into individual camp will receive a yellow card. A red card will be given for those who commit a second offense. This rule is exception to the initial position of prop in the central being changed due to the stuck of robot or the toss of individual ball.

**R25.** During the competition, contestants cannot touch any arena elements or robots, and their bodies cannot extend into competition area to affect opponent's score. If the change of arena elements causes any scores change, the score shall be invalid, and referee should try to restore the original state.

- The team will receive a violation, and a yellow card will be given if it affects the score or the progress of the match. Those who commit serious offense will be disqualified for single match.

### **Robot Contact Scoring Props in Individual Goal Area**

**R26.** Neither part of the robot is allowed to contacting the scoring props (including ball, cube and flag) that enter the individual goal area during the match.



- First infractions will receive a red card, the robot will be suspended and move out of the arena.

### Removing Props in Violation

**R27.** Robots shall not remove any arena props out of the arena.

- The team will receive a violation, and those who commit second offenses will be disqualified for single match.

### Mentoring in Violation

**R28.** No person (including but not limited to the parents or mentors of the team) other than the team members shall enter the competition area by any means, and no instruction shall be given in or outside the competition area in any form.

- The team will receive a verbal warning, and those who will receive a violation if they refuse to correct their mistake. Penalties may be upgraded until disqualify for single match.

### Off-Arena Contact

**R29.** During the competition, contestants are not allowed to have any direct contact with off-arena person and audiences, including but not limited to the delivery of the parts and Bluetooth controller.

- The team will receive a violation, and those who commit second offenses will be disqualified for single match.



## 7. Appeal and Arbitration

### 7.1 Results Confirmation

#### Results Confirmation

When a single match ends, captains of both teams need to confirm the results with the referees and then sign the score sheet. The committee will not accept any appeal of the match after the captains have signed and confirmed the result.

#### Dispute Settlement

If the participants on still disagree with the result of the competition and do not agree with the explanation of the referee, they can refuse to sign the result, but the participant must write down the situation in the remarks column of the scoring sheet before leaving.

### 7.2 Appeal Procedure and Valid Appeal Period

#### Appeal Procedure

Appeals should be lodged within the “valid appeal period” by the prescribed procedure and follow the civil participation spirit. The captain of the team needs to fill in the Appeal Form, then cooperates with the Arbitration Commission to investigate the actual situation. Both sides will be required to arrive at the designated place if the Arbitration Commission requires. During the investigation, the captain of the appeal team must be present, and only captains or contestants of both teams can be present. The Arbitration Commission has the right to communicate with the appealing party alone, avoiding the mentor, the parents of the contestants, their relatives, or friends. The appellant should express facts clearly and objectively, not being over-emotionally.

#### Valid Appeal Period

Normally, the appeal should be lodged within 30 minutes after the end of every



single match. The appellant and the respondent must be present before the time appointed by the referee.

### **Appeal Response**

Normally, the Arbitration Commission responds to the appeal after the end of the competition on the same day or before the start of the competition on the next day.

## **7.3 Invalid Appeal**

### **Overdue Appeal**

Appeals that are not lodged within the "valid appeal period" will be considered invalid and inadmissible. If the appellant fails to be present on time or leaves without any reason during the investigation, the appeal will be considered invalid. If the respondent fails to be present on time, the Arbitration Commission will directly determine the arbitration result and render it as a final result.

### **Appellants out of Stipulation**

The appellants must be the participating contestant and the appeal of another person is invalid. The Arbitration Committee will caution the offending team if parents, mentors, or other irrelevant persons participate in the arbitration process without the permission of the Arbitration Committee.

- Team or alliance will be disqualified entire competition for multiple invalid warnings.

### **Vague Appeal's Requests**

If the Arbitration Commission is unable to understand the appeal or conduct the normal investigation due to emotion factor of the appealing party, the team will receive a verbal warning.

- Team or alliance will be disqualified entire competition for multiple invalid warnings.

### **Uncivil Appeal**



Neither side shall make uncivil behavior nor offensive action and remarks.

- Team or alliance will be disqualified entire competition for multiple invalid warnings.

## 7.4 Arbitration Procedure

### Arbitration Procedure

The Arbitration Commission consists of the head referee, the arbitration consultant, and the competition technical director. The Arbitration Commission is responsible for accepting the appeals and conducting arbitration investigations, to ensure the smooth progress of the competition and the fairness and justice of the competition results. The playback videos and photographs of any competition may be inaccurate due to the shooting angle, which is only used as reference but not arbitration evidence.

### Arbitration Results

The arbitration results can be divided into “maintaining the original result of the match” or “re-match”, and the two teams shall not appeal again. If the arbitration result is a "re-match", the two teams shall have a re-match according to the time and arena stipulated in the Appeal Form. If either team fails to reach the arena within 5 minutes after the beginning of the match, the team shall be deemed to quit the match.

### Additional Remarks

The Arbitration Commission determines the final arbitration result, and neither side shall dispute the result of the appeal anymore.



## 8. Statement

MakeX Robotics Competition Committee reserves the final interpretation of *2022-2023 Season MakeX Explorer Eco-Pioneer Rules Guide*.

### 8.1 Rules Explanation

In order to ensure a fair competition and high-quality competition experience, MakeX Robotics Competition Committee has the right to update and complement this Rules Guide regularly, issue and implement the latest version before the competition.

During the competition, all matters not stated in the Rules Guide shall be decided by the referee team.

This Rules Guide is the basis for refereeing, and the referee team has the right of adjudication during the competition.

### 8.2 Disclaimer

All contestants in MakeX Robotics Competition shall fully understand that safety is the most important issue for the sustainable development of the MakeX Robotics Competition. To protect the rights and interests of all contestants and organizers, according to relevant laws and regulations, all mentors and contestants registered for the 2022-2023 MakeX Explorer Eco-Pioneer, shall acknowledge and abide by the following safety provisions:

- Contestants shall take adequate safety precautions when constructing the robots, and all parts used for constructing the robots shall be purchased from legal manufacturers.
- Contestants shall ensure that the structural design of the robots takes into account the convenience of the inspection and actively cooperate with the host of the competition.





- When modifying and using the parts with potential safety hazards for the robots, it must conform to the national laws, regulations, and quality & safety standards. Those operations shall be manufactured and operated by persons with relevant professional qualifications.
- During the competition, the teams shall ensure that all the actions such as construction, testing, and preparation will not do harm to their team and other teams, referees, staff, audiences, equipment, and arenas.
- In the process of construction and competition, if any action that may violate the national laws, regulations, or standards occurs, all consequences will be borne by the contestants themselves.

The competition kits and parts sold and provided by the supporter, Shenzhen Makeblock Co., Ltd., shall be used by the instructions. Shenzhen Makeblock Co., Ltd. and MakeX Robotics Competition Committee will not be responsible for any injury or loss of property caused by improper use.

The official language for MakeX is Chinese. English or other language translations are prepared to facilitate the team's preparation process. All documents translated to English are for reference only.

### 8.3 Copyright Declaration

Shenzhen Makeblock Co., Ltd. reserves the copyright of this Rules Guide. Without the written consent or authorization from Shenzhen Makeblock Co., Ltd, any entity or individual may not reproduce, including but not limited to any network media, electronic media or written media.



## Appendix 1. Awards and Annual Points

In 2022-2023 season, according to the scale of the competition and the number of teams, the competition will be classified into Points Race/Regional Competition, National Competition, International/Intercontinental Competition, and World Championship. In MakeX Explorer, participating teams can obtain the points according to the number of wins, ties and losses in the match, and each team can voluntarily sign up for all kinds of Points Race throughout the season to accumulate the annual points. The accumulation of annual points is based on the Team Number.

In each competition, the annual points that teams can obtain are based on the win-loss points they get for every single match in qualification round and championship round.

| Category  | Rounds                   | Win | Tie | Loss |
|---|--------------------------|-----|-----|------|
| <b>Points Race/Regional Competition</b>           | Qualification            | 5   | 2   | 1    |
|   | Elimination (Best of 3)  | 10  | /   | 2    |
| <b>National Competition</b>                       | Qualification            | 10  | 4   | 2    |
|   | Elimination (Best of 3)) | 20  | /   | 4    |
| <b>International/Intercontinental Competition</b> | Qualification            | 15  | 6   | 3    |
|   | Elimination (Best of 3)) | 30  | /   | 6    |

Teams that have won the champion, runner-up, second runner-up and other special awards can obtain additional annual points. For the details of award list, please refer to **2022-2023 MakeX Awards Guide**.

| Category         | Awards   | Regional /Points Race | National | Intercontinental |
|------------------|----------|-----------------------|----------|------------------|
| <b>Explorer,</b> | Champion | 15                    | 30       | 45               |



|                                |                            |    |    |    |
|--------------------------------|----------------------------|----|----|----|
| <b>Challenge &amp; Premier</b> | Runner-up                  | 10 | 20 | 30 |
|                                | Second Runner-up           | 5  | 10 | 15 |
|                                | Innovative Design Award    | -  | 5  | 10 |
|                                | Engineering Notebook Award | -  | 5  | 10 |
| <b>Excellence Award</b>        | Outstanding Mentor Award   | -  | -  | -  |
|                                | Promotion Ambassador Award | -  | 5  | 10 |
|                                | Technology Sharing Award   | -  | 5  | 10 |
|                                | MakeX Spirit Award         | -  | -  | 10 |

For example, team X20000 won the champion in one Points Race, and all the results show as below.

|                       |                       |                       |                       |                                     |
|-----------------------|-----------------------|-----------------------|-----------------------|-------------------------------------|
| Qualification Round 1 | Qualification Round 2 | Qualification Round 3 | Qualification Round 4 | Annual Points from Qualification=13 |
| Win (5)               | Loss (1)              | Tie (2)               | Win (5)               |                                     |
| Top Eight Battle      | Semi-final            | Final                 |                       | Annual Points from Elimination=30   |
| Win (10)              | Win (10)              | Win (10)              |                       |                                     |

The total annual points that team X20000 obtains = 13+30+15 = 58.



## Appendix 2. Engineering Notebook Guideline

### \*Instruction:

1. The value of engineering notebook: It helps the team establish files and record the whole learning process. Therefore, it is necessary to record engineering notebook during the entire preparation for the competition.

2. Engineering notebook submission: Teams can use online documents or handwriting. No matter which way to use, each team must submit a paper version onsite.

Paper engineering notebook: As the Challenge & Premier programs require the assessment process, one copy of the paper version shall be submitted by each team to the judges onsite. If there is no assessment process (Starter & Explorer), each team will need to submit one copy of the paper version to the staff at the inspection area. Teams that cannot submit the original engineering notebook should prepare their own copies.

3. An engineering notebook will be required for the evaluation of all technical awards. Please refer to the Competition Guide for the evaluation criteria.

#### **Basic Requirements for Cover**

The team's name, team number, and competition program must appear on the cover of the engineering notebook.

#### **Basic Requirements for Contents**

##### **1. Clear content**

Creating content brings convenience for the judges to review and quickly find the corresponding section.

##### **2. Process records (Required)**

Every improvement of the robots should be recorded from prototype design, construction, to the debugging. Keep pictures of all manuscripts, design drawings, calculation processes, circuit diagrams, etc., and insert them into the engineering

notebook in the form of pictures.

- 1) Schedule of robot building progress
- 2) Design inspiration/sketch
- 3) Technical principle (it can be disassembled into different parts)
- 4) Production step by step (with clear pictures)
- 5) Problems encountered and solutions

Examples of problems:

What technical failures did you encounter? Why did you fail? How did you solve the problems finally?

What efforts have you made for the robots? What improvements have been achieved?

Does your project progress schedule go as planned? What accidents or delays have occurred? How to fix it?

Have there been any disputes among the team members and how to settle them in the end?

### **3. Projects summary**

- 1) The structure and function of the project (with pictures and text enclosed)
- 2) The technical innovations of the project
- 3) Competition strategies for scoring and defense

### **4. Team introduction**

- 1) A brief biography of each team member and their role on the team
- 2) Culture displaying (logo, team flag, slogan, posters, T-shirt, etc.)
- 3) Excellent achievements sharing (Stories)

### **5. Feelings and other things you want to share (optional)**

- 1) Achievement in the competition (Technical)
- 2) Growth in the competition (Spiritual)
- 3) Suggestions for competition

## Appendix 3. Robot Self-Check Form

# MakeX Explorer Robot Self-Check Form

Please follow the requirements of the self-checklist and check the box if your robot meets the requirements. And submit the signed self-checklist during the inspection day. Thanks for your cooperation.

Team Name: \_\_\_\_\_ Mentor Name: \_\_\_\_\_  
 Team Member: \_\_\_\_\_

|   |
|---|
| 1. Basic Information  |
| Robot Mainboard Number: _____ (A 12-bit code consist of numbers and alphabet, please find from the CyberPi)   |
| Total quantity of mainboard: 1 <input type="checkbox"/> Yes   |
| Robot Size: Length _____ mm, Wide _____ mm, Height _____ mm.<br>(Robot size should not exceed: length 320mm, width 320mm, height 360mm. Please measure your robot and fill in the maximum extension size)   |
| Robot Wheel Diameter: _____ mm (Should not exceed 70mm)   |
| Robot Weight: _____ kg (Should not exceed 4kg)  |
| Environmental Flag: Length _____ mm, Wide _____ mm, Height (of flagpole) _____ mm.<br>(Environmental flag surface is no less than 80mm(length)* 60mm(wide). The shape of flagpole and pedestal is unlimited. The vertical projection of this part should not exceed 30mm*30mm, with the length no less than 100mm.) |
| 2. Equipment  |
| Name of motors:   |
| Name of servos:   |
| Total quantity of motors and servos <8 <input type="checkbox"/> Yes   |



| Quantity of Bluetooth controller <input type="checkbox"/> Yes                                   |                               |   |                              |
|---|-------------------------------|---|------------------------------|
| Wireless control: Bluetooth version: BT4.0 <input type="checkbox"/> Yes                         |                               |   |                              |
| Name and parameters of battery: (18650 Lithium-ion , 3.7V 2500mAh) <input type="checkbox"/> Yes |                               |   |                              |
| Others  |                               |   |                              |
| No.   | Items                         | Specific Requirements   | Meet required States         |
| 1   | Safety Protection             | The robot's structure that may do harm to people is required to ensure safety protection in the process of robot loading, unloading and transporting.   | <input type="checkbox"/> Yes |
| 2   | Competition arena Destruction | Competition arena destruction is prohibited in the process of robot loading, unloading and transporting.  | <input type="checkbox"/> Yes |
| 3   | High-power Equipment          | High power equipment is not available during competition and preparation.   | <input type="checkbox"/> Yes |
| 4   | Energy Storage Equipment      | Please keep safe while using energy storage devices (springs).  | <input type="checkbox"/> Yes |
| 5   | Banned Material               | Robots are not allowed to use the flammable gases, pyrotechnic equipment, hydraulic components, mercury-containing components, exposed hazardous materials, unsafe counterweights, designs that may cause entanglement and competition delays, sharp edges and angles, materials containing liquids or gelatinous substances, and any part that the electric current on the robot may be conducted to the competition area. | <input type="checkbox"/> Yes |
| 6   | Personal Safety               | Long hairs shall be tied up; contestants are prohibited from wearing toe-baring shoes to enter the competition area.  | <input type="checkbox"/> Yes |



|   |                  |  |                              |
|---|------------------|--|------------------------------|
| 7 | Sensor           | Robots are prohibited from using any sensors that can interfere with the sensory capabilities of other robots  | <input type="checkbox"/> Yes |
| 8 | Self-made Parts  | Teams can use self-made parts by 3D printing or corrugated cardboard, woods, acrylic and Rubber band, etc. All self-made parts cannot have producers' logo.  | <input type="checkbox"/> Yes |
| 9 | Mechanical Parts | Teams can use self-made mechanical parts by 3D printing or laser cutting. Teams must not use commercial structures with mature design, including but not limit to multi-DOF robotic arms or hands. | <input type="checkbox"/> Yes |

Our team has checked our own robot according to the self-check form and has filled in the actual data on this form and submitted it to MakeX Robotics Committee. We promise that we will participate in the competition in the above state and will report any changes in time. During the competition, if the robot does not comply with the requirement or our team uses any in-compliance robot, the competition result will be disqualified and all responsibilities will be taken by the team without objection.

Team Leader Signature:

Date:





## Appendix 4. MakeX Explorer Eco-Pioneer Penalties List

| Item                               | Penalty Description   | Violation | Yellow card | Suspend | Red Card | Disqualify Single Match | Disqualify Entire Match |
|------------------------------------|---|-----------|-------------|---------|----------|-------------------------|-------------------------|
| Destructing or Contaminating Arena | The robot that violates the rules will be suspended. Team with two violations will be disqualified entire competition.  |           |             | ✓       |          |                         | ✓                       |
| Destructing Other Robots           | The robot that violates the rules will be suspended. Team with two violations will be disqualified entire competition.  |           |             | ✓       |          |                         | ✓                       |
| Robots Out of Boundary             | The team who couldn't return to its own camp on time will be given a violation. Team with two violations will be disqualified for single competition.   | ✓         |             |         |          | ✓                       |                         |
| Using Banned Materials             | The robot that violates the rules will be suspended. If the robot continues to be a participant, contestant should modify it to accept re-inspection. Team with two violations will be disqualified entire competition. |           |             | ✓       |          |                         | ✓                       |
| Other Unsafe Factors               | The robot that violates the rules will be suspended. The robot needs to be modified and re-inspected before it can be back to the match. Team with two violations will be disqualified entire competition.              |           |             | ✓       |          |                         | ✓                       |



| Item                                    | Penalty Description   | Violation | Yellow card | Suspend | Red Card | Disqualify Single Match | Disqualify Entire Match |
|---|---|-----------|-------------|---------|----------|-------------------------|-------------------------|
| Contestants' Requirements               | Team or alliance that violates the rules, will be disqualified single match. The team need to re-adjust and have a re-inspection before come back to the match. Team with two violations will be disqualified entire competition.                     |           |             |         |          | ✓                       | ✓                       |
| Can't Arrival the Arena on Time         | Disqualify the single match.  |           |             |         |          | ✓                       |                         |
| Contestants' Standing Position          | The team will receive a verbal warning, and those who commit a second offense will receive a violation. Contestants with serious offense will be disqualified for single match.   | ✓         |             |         |          | ✓                       |                         |
| Debugging overtime in elimination round | The team will receive a verbal warning, and those who commit a second offense will receive a violation.   | ✓         |             |         |          |                         |                         |
| Operating the Robot in Advance          | The team will receive a violation, and those who commit a second offense will receive a yellow card.  | ✓         | ✓           |         |          |                         |                         |
| Delay the end of the Competition        | The team will receive a violation. If the delay in ending competition gives the offending team a scoring advantage, the referee shall judge it as an invalid score and the offending team is required to restore the arena to its original condition. | ✓         |             |         |          |                         |                         |



| Item  | Penalty Description  | Violation | Yellow card | Suspend | Red Card | Disqualify Single Match | Disqualify Entire Match |
|---|--|-----------|-------------|---------|----------|-------------------------|-------------------------|
| Bringing Banned Electronic Device             | The team will receive a violation for the first time, a yellow card for a second time. Those who commit serious offense will be disqualified for single match.   | ✓         | ✓           |         |          | ✓                       |                         |
| Using Bluetooth Controller in Automatic Stage | The team will receive a violation. The team that uses blue-tooth controller during the automatic stage will receive a red card. Those who commit serious offense will be disqualified for single match.                          | ✓         |             | ✓       | ✓        | ✓                       |                         |
| Operating Suspended Robot                     | Disqualify for single match.   |           |             |         |          | ✓                       |                         |
| Robot's Left-Behind Components                | The team will receive a violation in case it affects the progress of the competition. Team with two violations will be given a yellow card.  | ✓         | ✓           |         |          |                         |                         |
| Robot In-conformity during the competition    | The team will receive a red card. Except for those situations that are caused by non-subjective factors, including being hit by opponents' arena element or other external forces, which leads to robots deforming or oversized. |           |             | ✓       | ✓        |                         |                         |
| Toss in Violation                             | The team will receive a yellow card. The arena elements need to be restored if it causes any changes of arena elements in the opponent's side.   |           | ✓           |         |          |                         |                         |



| Item  | Penalty Description  | Violation | Yellow card | Suspend | Red Card | Disqualify Single Match | Disqualify Entire Match |
|---|--|-----------|-------------|---------|----------|-------------------------|-------------------------|
| Difficult Detachment of Arena Elements and Robots | Robot suspended. The robot needs to be modified and re-inspected before come back the match. Team with two violations will be disqualified for entire competition.   |           |             | ✓       |          |                         | ✓                       |
| Enter Opponent's Camp                             | Yellow card. The robot that enters the opponent's area must return to its own area within three seconds and the referee will give a countdown reminder.  |           | ✓           |         |          |                         |                         |
| Restricting the Movement of Opponent's Robot      | The team will receive a violation, and those who commit serious offense will receive a yellow card.  | ✓         | ✓           |         |          |                         |                         |
| Contact in Violation                              | Maliciously grab the ball in central area into individual camp in automatic stage will receive a yellow card. A red card will be given for second offense. This rule is exception to the initial position of prop in the central being changed due to the stuck of robot or the toss of individual ball. |           | ✓           | ✓       | ✓        |                         |                         |
|   | Contestants cannot touch any arena elements or robots, and their bodies cannot extend into competition area to affect opponent's score. Receive violation, and a yellow card if affects the score or the progress of the match. Serious offense will be disqualified for single match.                   |           | ✓           |         |          | ✓                       |                         |



| Item  | Penalty Description  | Violation | Yellow card | Suspend | Red Card | Disqualify Single Match | Disqualify Entire Match |
|---|--|-----------|-------------|---------|----------|-------------------------|-------------------------|
| Robot Contact Scoring Props in Individual Goal Area | First infractions will receive a red card, robot will be suspended and move out of the arena.  |           |             | ✓       | ✓        |                         |                         |
| Removing Props in Violation                         | The team will receive a violation, and those who commit second offenses will be disqualified for single match.   | ✓         |             |         |          | ✓                       |                         |
| Mentoring in Violation                              | The team will receive a verbal warning, and those who will receive a violation if they refuse to correct their mistake. Penalties may be upgraded until disqualify for single match. | ✓         |             |         |          | ✓                       |                         |
| Off-Arena Contact                                   | The team will receive a violation, and those who commit second offenses will be disqualified for single match.   | ✓         |             |         |          | ✓                       |                         |



# Appendix 5. MakeX Explorer Eco-Pioneer Score Sheet

## MAKE X ROBOTICS COMPETITION

### 2022-2023 MakeX Explorer Eco-Pioneer - Scoring Results

Competition Info: Qualification Round  / Elimination Round  (Arena) No. \_\_\_ (Session)

| Registration         | Match Points            |              |                         | Winner        |
|----------------------|-------------------------|--------------|-------------------------|---------------|
|                      | Red Alliance            |              | Blue Alliance           |               |
| <b>Red Alliance</b>  |                         |              |                         | Red Alliance  |
| Team 1 (No.) :       | <i>(40 points each)</i> | Cube         | <i>(40 points each)</i> |               |
| Team 2 (No.) :       | <i>(60 points each)</i> | Green Ball   | <i>(60 points each)</i> |               |
|                      | <i>(30 points each)</i> | Yellow Ball  | <i>(30 points each)</i> |               |
| <b>Blue Alliance</b> |                         |              |                         | Blue Alliance |
| Team 1 (No.) :       | <i>(50 points each)</i> | Flag         | <i>(50 points each)</i> |               |
| Team 2 (No.) :       |                         | Penalty      |                         |               |
|                      |                         | Total Points |                         |               |

|   |   |  |
|---|---|--|
| <b>Captain of Red Alliance:</b>                           | <b>Captain of Blue Alliance:</b>                          | <b>Remark</b>  |
| <i>(Please confirm the scoring results and sign here)</i> | <i>(Please confirm the scoring results and sign here)</i> |  |
| <b>Referee of Red Alliance:</b>                           | <b>Referee of Blue Alliance:</b>                          |  |
| <i>(Please confirm the scoring results and sign here)</i> | <i>(Please confirm the scoring results and sign here)</i> | <i>(If there's any disagreement about the results, please write down the situation clearly and sign here.)</i> |



## Appendix 6. Supplementary Explanation of Competition Procedure

### Engineering Notebook Submission

MakeX encourages teams to write engineering notes for their robots, and excellent engineering notes will be an important basis for team awards. Please refer to the pre-competition notice and competition guide for the submission of paper engineering notebook and awards setting for each competition. Normally, in medium to large-scale competition, the submission of hard copy version of engineering notebook is mandatory and will be used as an important basis for awarding. Please refer to the appendix 2 for the engineering notebook guideline.

### Pits Area Decoration

Each team can set up and decorate their own team area in the pits area, as well as promote their team for the awarding. The pits area is the area for team's resting and robot debugging, so please keep it clean and tidy. Suggested are as follows:

- Display content (to be provided by the team)
- Team flag
- 3-4 high-resolution photos of the team
- Team introduction (no more than 200 words)
- Team peripheral display (if any)

### Display Format

Team poster/display board+ team flag + team souvenirs (if any) +team members/mentor for presenting

### Practice Round

Teams who have finished their robot inspection can participate in practice round. The schedule will be announced at the entrance in form of notices, and teams are required to queue in line before entrance. Not all competitions have a practice round, which can be informed based on actual situation.



## Appendix 7. Competition Resources

Competition resources include but are not limited to official resources provided by the committee, such as Competition Guide, Equipment Instructions, Rules Videos, etc.

The contestants are obliged to keep abreast of the update of competition resources before the competition, and any problems caused by the contestants' failure to keep abreast of the updates shall be borne by the contestants themselves. All official competition resources will be updated in MakeX Website.

MakeX Robotics Competition Committee will revise and improve the Rules Guide with the progress of the competition and the new version will be announced in MakeX Website. The contestants and mentors can download the latest version in MakeX Website.

MakeX Website Download <https://www.makex.cc/en/information/download>.

MakeX Official Website: <https://www.makex.cc/en>.

Any Feedback & Question Please Sent to:

[makex\\_overseas@makeblock.com](mailto:makex_overseas@makeblock.com)



**MAKE** 

Edited By Makex Robotics Competition Committee

Official Website:  
[www.makex.cc/en](http://www.makex.cc/en)

Email:  
[makex\\_overseasa@makeblock.com](mailto:makex_overseasa@makeblock.com)

 Facebook : Makex

RULES GUIDE  
MAKEEX EXPLORER